

P-Channel Enhancement Mode Power MOSFET

Description

The PE2023 uses advanced trench technology to provide excellent $R_{DS(ON)}$ and low gate charge. It can be used in a wide variety of applications.

General Features

- $V_{DS} = -20V, I_D = -3.2A$

$R_{DS(ON)} < 95m\Omega @ V_{GS}=-4.5V$

$R_{DS(ON)} < 120m\Omega @ V_{GS}=-2.5V$

- High Power and current handling capability
- Lead free product is acquired
- Surface Mount Package

Application

- PWM applications
- Load switch
- Power management

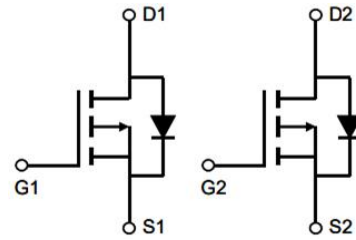

Schematic diagram

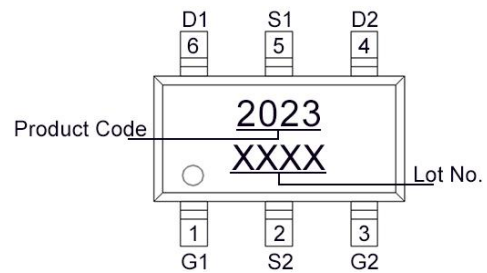

Marking and pin assignment

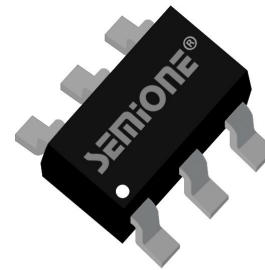

SOT-23-6L

Absolute Maximum Ratings (TA=25°C unless otherwise noted)

Parameter	Symbol	Rating	Unit
Drain-Source Voltage	V_{DS}	-20	V
Gate-Source Voltage	V_{GS}	± 12	V
Drain Current-Continuous	I_D	-3.2	A
Pulsed Drain Current (Note 1)	I_{DM}	-10	A
Maximum Power Dissipation	P_D	1	W
Operating Junction and Storage Temperature Range	T_J, T_{STG}	-55 To 150	°C

Thermal Characteristic

Thermal Resistance, Junction-to-Ambient (Note 2)	$R_{\theta JA}$	125	°C/W
--	-----------------	-----	------

Electrical Characteristics (TA=25°C unless otherwise noted)

Parameter	Symbol	Condition	Min	Typ	Max	Unit
Off Characteristics						
Drain-Source Breakdown Voltage	BV_{DSS}	$V_{GS}=0V, I_D=-250\mu A$	-20	-	-	V
Zero Gate Voltage Drain Current	I_{DSS}	$V_{DS}=-20V, V_{GS}=0V$	-	-	-1	μA
Gate-Body Leakage Current	I_{GSS}	$V_{GS}=\pm 12V, V_{DS}=0V$	-	-	± 100	nA
On Characteristics (Note 3)						
Gate Threshold Voltage	$V_{GS(th)}$	$V_{DS}=V_{GS}, I_D=-250\mu A$	-0.45	-0.7	-1	V
Drain-Source On-State Resistance	$R_{DS(on)}$	$V_{GS}=-4.5V, I_D=-2.8A$	-	68	95	m Ω
		$V_{GS}=-2.5V, I_D=-2.2A$	-	95	120	m Ω
Forward Transconductance	g_{FS}	$V_{DS}=-5V, I_D=-2.8A$	-	9.5	-	S
Dynamic Characteristics (Note 4)						
Input Capacitance	C_{iss}	$V_{DS}=-10V, V_{GS}=0V,$ $F=1.0MHz$	-	405	-	pF
Output Capacitance	C_{oss}		-	75	-	pF
Reverse Transfer Capacitance (Note 4)	C_{rss}		-	55	-	pF
Switching Characteristics						
Turn-on Delay Time	$t_{d(on)}$	$V_{DD}=-10V, I_D=-1A, R_L=1\Omega,$ $V_{GS}=-4.5V, R_G=3\Omega$	-	11	-	nS
Turn-on Rise Time	t_r		-	35	-	nS
Turn-Off Delay Time	$t_{d(off)}$		-	30	-	nS
Turn-Off Fall Time	t_f		-	10	-	nS
Total Gate Charge	Q_g	$V_{DS}=-10V, I_D=-3A, V_{GS}=-4.5V$	-	3.3	-	nC
Gate-Source Charge	Q_{gs}		-	0.7	-	nC
Gate-Drain Charge	Q_{gd}		-	1.3	-	nC
Drain-Source Diode Characteristics						
Diode Forward Voltage (Note 3)	V_{SD}	$V_{GS}=0V, I_S=-1.3A$	-	-	-1.2	V
Diode Forward Current (Note 2)	I_S		-	-	-1.3	A

Notes:

1. Repetitive Rating: Pulse width limited by maximum junction temperature.
2. Surface Mounted on FR4 Board, $t \leq 10$ sec.
3. Pulse Test: Pulse Width $\leq 300\mu s$, Duty Cycle $\leq 2\%$.
4. Guaranteed by design, not subject to product.

Typical Electrical and Thermal Characteristics

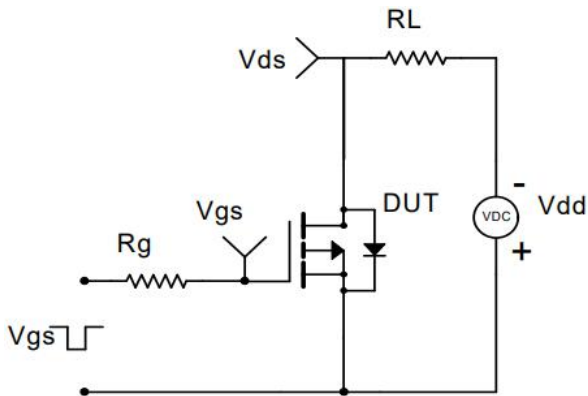

Figure 1 Switching Test Circuit

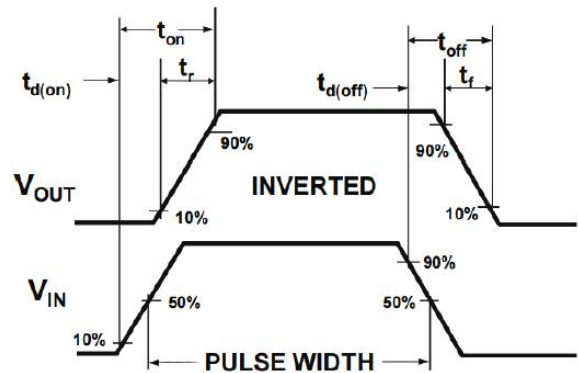
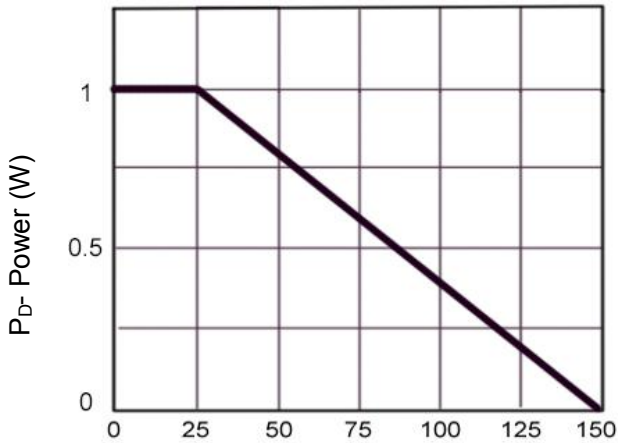
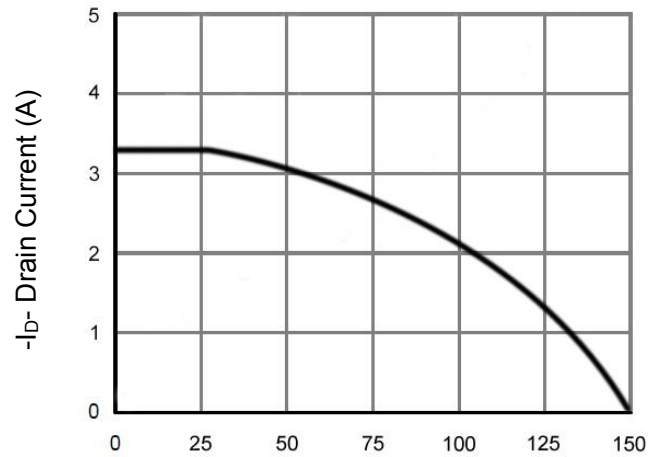

Figure 2 Switching Waveform



T_J-Junction Temperature (°C)

Figure 3 Power De-rating



T_J-Junction Temperature (°C)

Figure 4 Drain Current

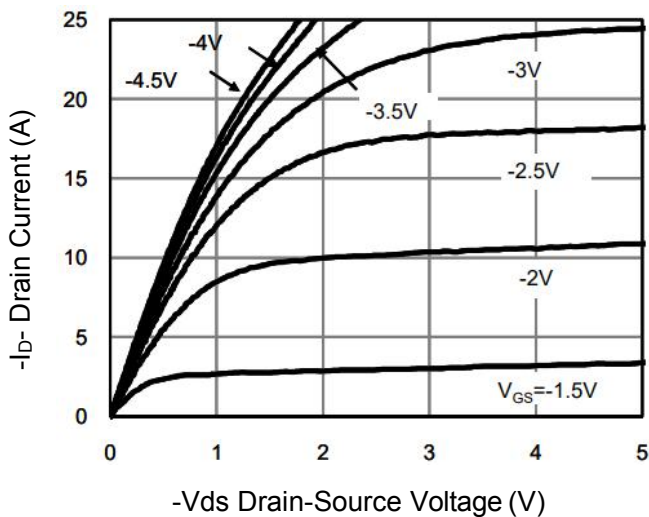

Figure 5 Output Characteristics

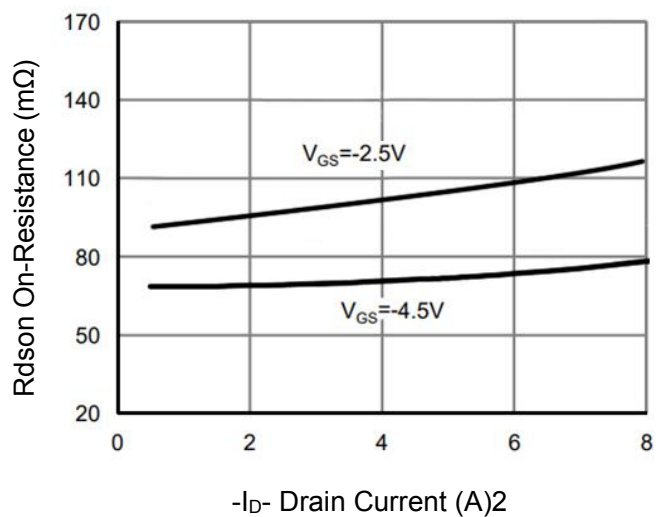

Figure 6 Rdson vs Drain Current

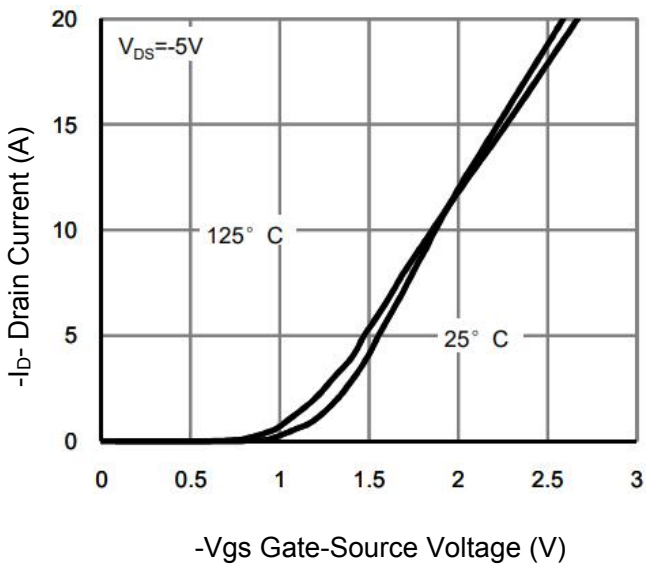

Figure 7 Transfer Characteristics

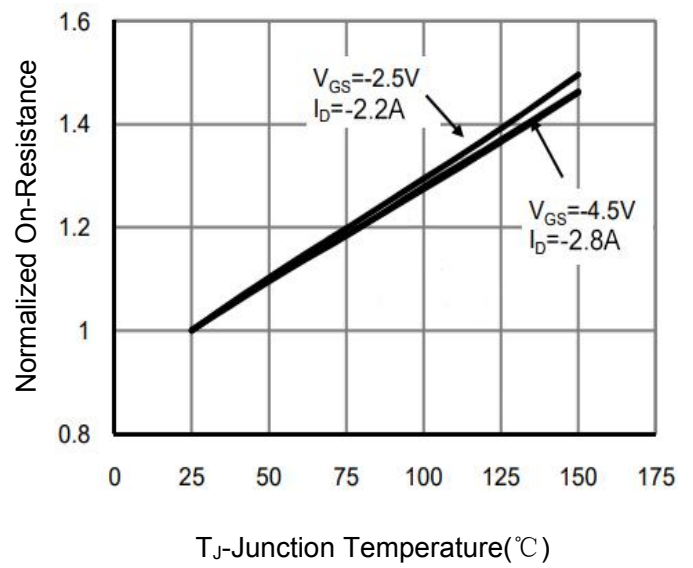

Figure 8 Rdson vs Junction Temperature

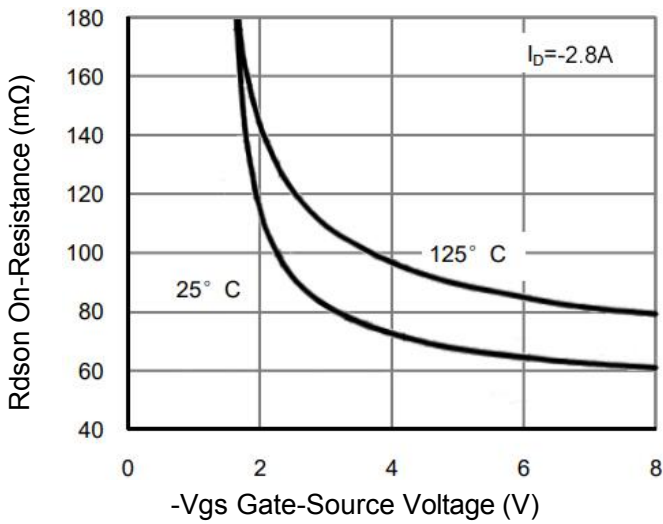

Figure 9 Rdson vs Vgs

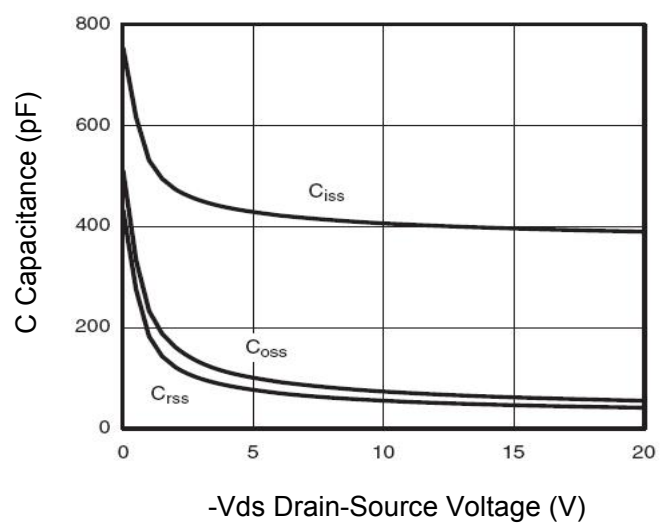

Figure 10 Capacitance vs Vds

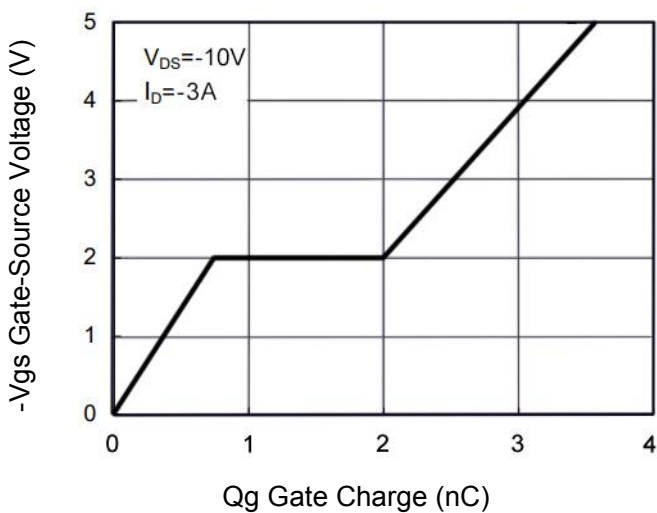

Figure 11 Gate Charge

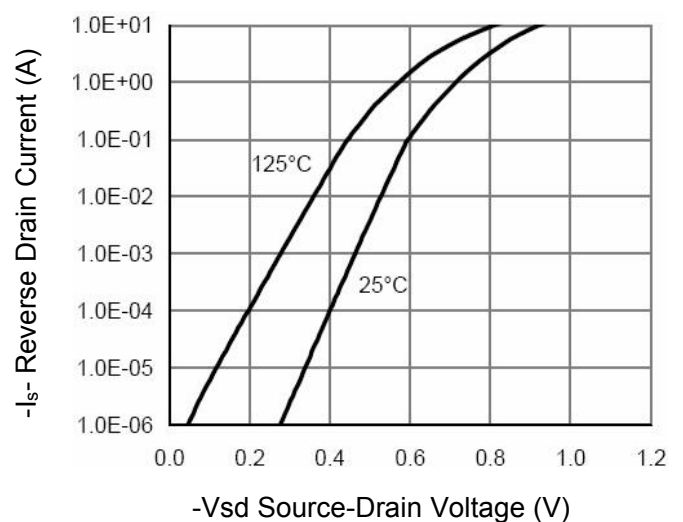

Figure 12 Source- Drain Diode Forward

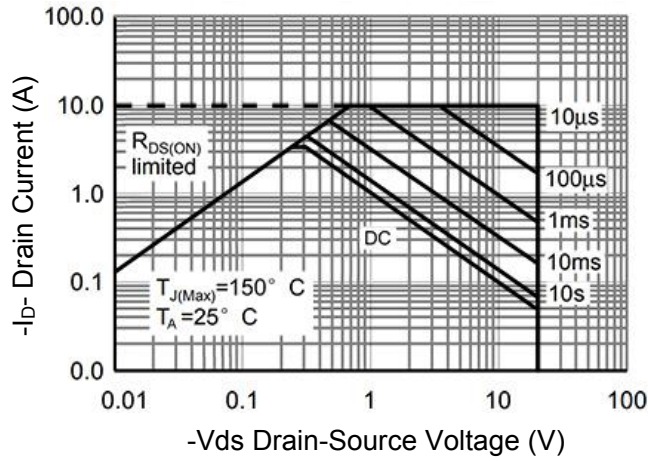

Figure 13 Safe Operation Area

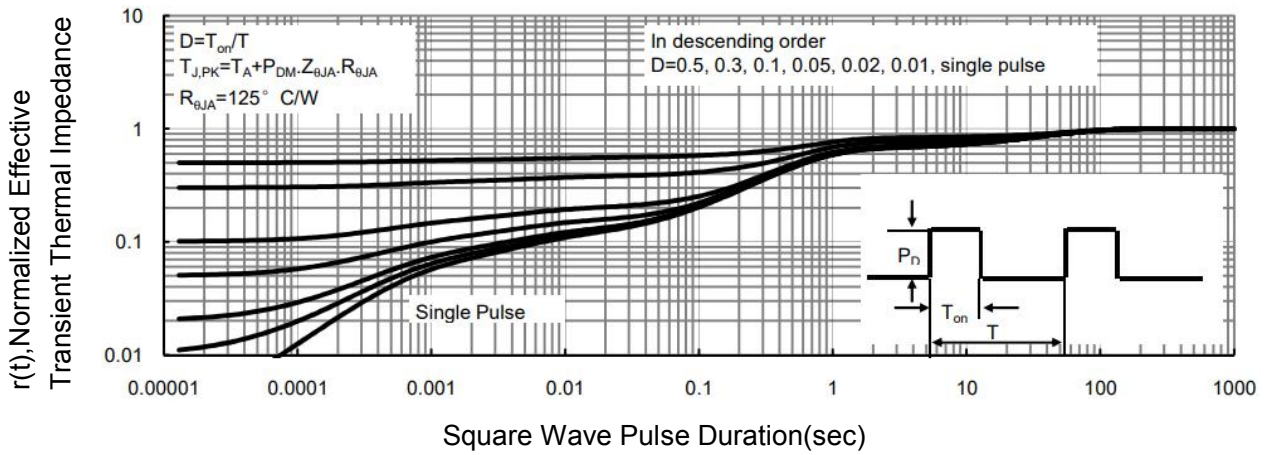
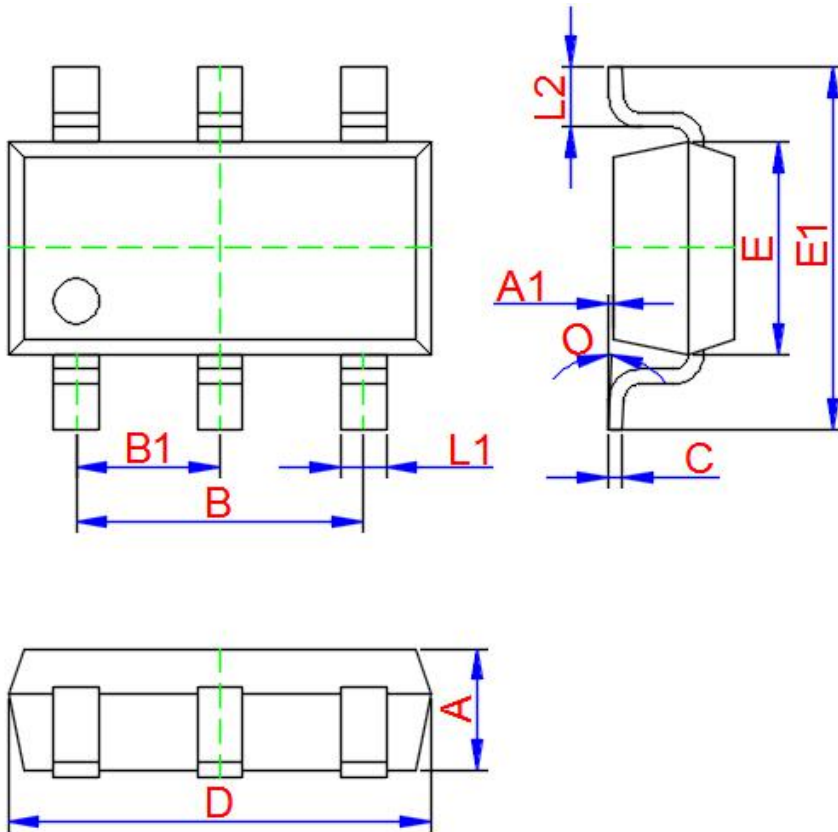

Figure 14 Normalized Maximum Transient Thermal Impedance

SOT-23-6L Package Information



Symbol	Dimensions In Millimeters		
	Min.	Typ.	Max.
A	1.050	1.100	1.150
A1	0.000	0.050	0.100
L1	0.300	0.400	0.500
C	0.100	0.150	0.200
D	2.820	2.920	3.020
E	1.500	1.600	1.700
E1	2.650	2.800	2.950
B	1.800	1.900	2.000
B1	0.950 TYP.		
L2	0.300	0.450	0.600
O	0°	4°	8°